

Cotton Hand Carder

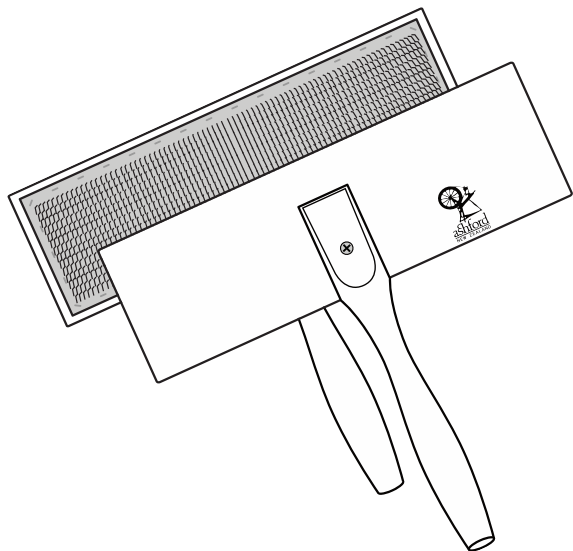

1. Place fibre on one carder. Hold the filled carder in your left hand using an underhand grip (see diagram). Hold the other carder in your right hand with an overhand grip and gently brush the fibre starting at the tips. Continue brushing gradually working up the fibre until the carders overlap completely. Repeat the process until all the fibre is transferred from one carder to the other and it is soft and airy.
3. Make a rolag by rolling the carded fibre from the top edge towards the bottom (handle end) and remove from the carder. Spin from one end.

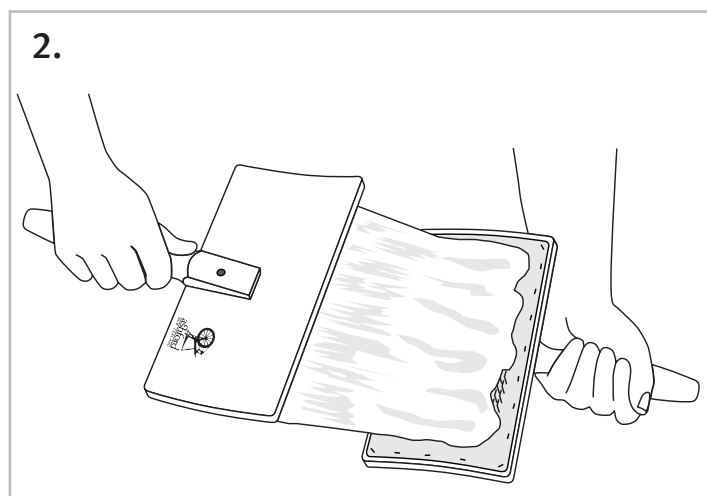

Assembly Instructions

Secure the handles to the bats with the screws provided. Ensure that the screw heads are flush with the surface. Use wood glue for extra strength. Use the sandpaper supplied to remove any sharp edges and corners.

Carding with Ashford Hand carders

Use the hand carders in pairs to make soft and airy rolags for fine spinning. Also blend colours and fibres.

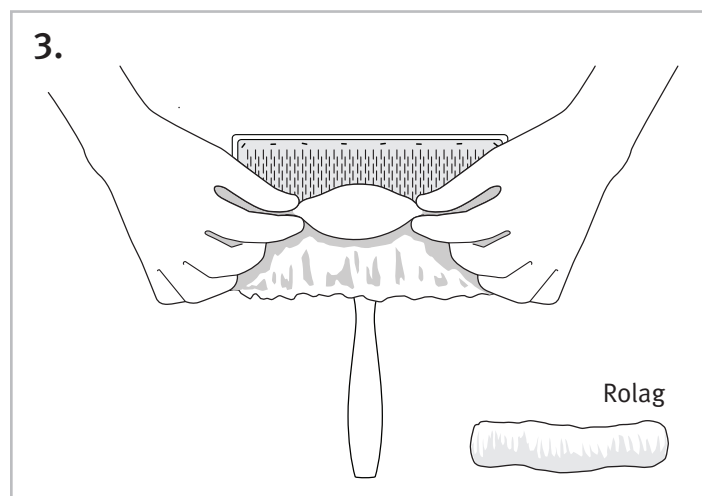

HCC050820V2

MORE CARDING EQUIPMENT

Drum Carders

The Ashford Drum Carder - Fine or Superfine 20cm/8"

This new, improved model has two ratios for even more flexibility and control when carding and blending. Use the 6:1 ratio to prepare your fleece. The controlled intake and carding will produce a smooth even batt ready for blending, spinning or felting. Use the 4:1 ratio to blend sliver, colours and different fibre types consistently into an open and airy batt. Adjustable drum to suit all fibres. Includes a packer brush to control fine low crimp fibres and increase the size of the batt.

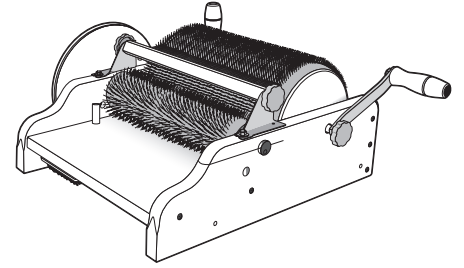

The Ashford Wide Drum Carder 30cm/12"

This new model has even more flexibility and control when carding and blending. The controlled intake and carding will produce a smooth even batt ready for blending, spinning or felting. Adjustable drum clearance - allows you to set the teeth distance for total control of your fibre. Includes a packer brush to control fine low crimp fibres and increase the size of the batt.

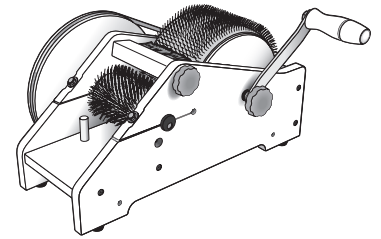

The Ashford Wild Drum Carder 10cm/4"

The Wild carder has been specifically designed for today's fabulous, fun and funky art yarns. The extra long 72ppi teeth allow you to include differing fibres, fabric, ribbons, feathers, paper and novelties to create unique blends. The packer brush is adjustable and will control fine, low-crimp fibres and increase the size of the batt. The drum clearance is also adjustable which allows you to set the teeth distance for total control of your fibre.

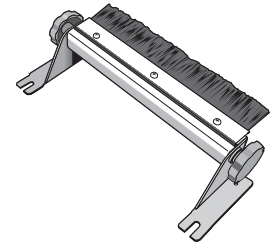

The Ashford Drum Carder Packer Brush

Adjustable packer brush to smooth, control and pack more fibres onto the large drum. Card mohair, angora, alpaca and other fine low crimp fibres. Fits all Ashford drum 20cm/8" carders.

Hand Carders

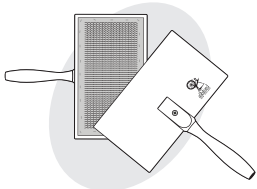

Standard Hand Carder

Available with either a medium cloth for most fibres (72 point) or fine cloth for fine fibres (108 point).

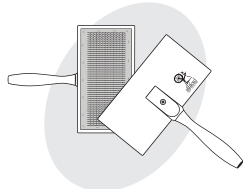

Hand Carder Small

Easy and light to use and transport. Available 72 or 108 point cloth.

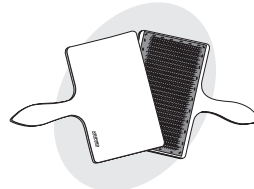

Student Hand Carder

Strong with comfortable handle. 72 point cloth.

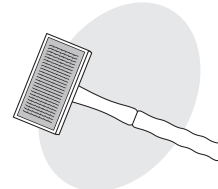

Flick Carder

Card individual staples of fibre to spin worsted yarns. 72 point cloth.

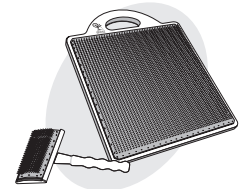

Blending Board

Blend fabulous fibres in your favourite colours. Large 30 x 30cm carding area. 108 point cloth.

Books



Ashford Book of Carding by Jo Reeve

This is a practical and inspirational guide to carding fleece, slivers and exotic fibres. Written for the hand spinner and felter, and everyone who loves fibre, there are sections on using flick, hand and drum carders, fibre and colour blending, colour theory and four innovative projects. Step by step instructions

and full colour photographs envelope you in a world of colour, texture and the endless possibilities of fibre.

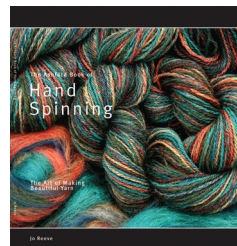

The Ashford Book of Hand Spinning by Jo Reeve

Learn to hand spin with fibre artist Jo Reeve. Jo, the author of the very popular Ashford Book of Carding, has twenty-seven years of spinning experience and will show you how to spin from the beginning through to advanced techniques. Learn how to create unique yarns using different techniques and fibres and make five easy projects

using your handspun yarn. Step by step instructions and gorgeous colour photographs will take you on a new journey of creativity.